

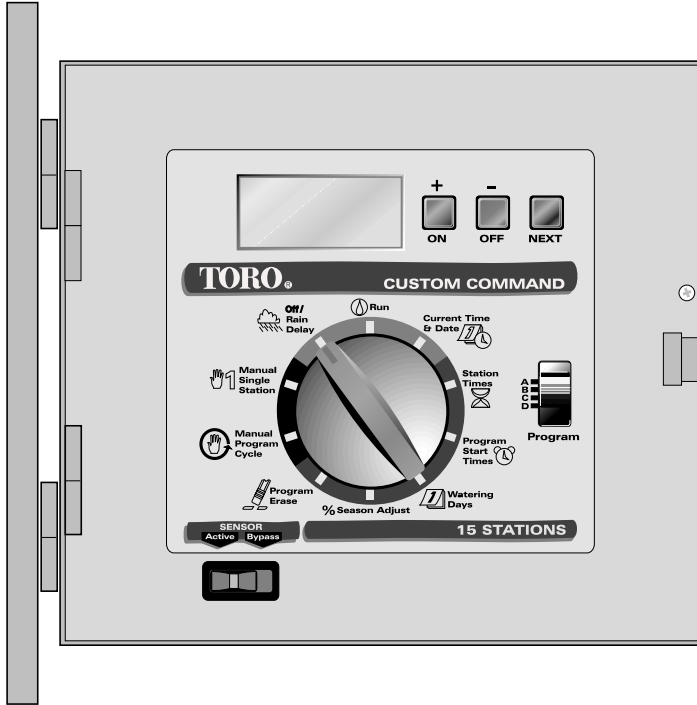

CUSTOM COMMAND™ CONTROLLER SERIES



User's Guide

Español - P. 31
Français - P. 65

FEATURES

Thank you for purchasing a Custom Command controller. Listed below are some important features you should be aware of before you begin programming. Details on how to implement these features are described on the following pages.

- Four fully independent programs that can run concurrently
- Watering programmable for days of the week, odd days, even days or intervals from 1 to 30 days. Selective removal of days from the Odd/Even schedule
- 365-day calendar, with automatic compensation for leap year
- Sixteen total start times to use in any program
- Start time stacking overlap protection within each program
- Station watering time from 0 minutes to 10 hours in 1-minute increments
- Program erase independent for each program
- Non-volatile memory that retains programmed information for up to 30 years in the event of a power failure
- Accurate time and date retention during power failures for up to 90 days continuous via a 9-volt alkaline battery (included)
- % Season Adjust from 0 to 200% in 10% increments
- Rain delay programmable to 7 days
- Self-diagnostic electronic circuit breaker that identifies and overrides faulty stations
- Master valve/pump start operation selectable per program
- Complete manual operations available by station and program
- Sensor switch-ready for operation with any normally-closed rain switch device
- Slide switch control provided for rain switch sensor override
- Unique modular design for ease of installation and service

To take full advantage of all Custom Command features, please review the User's Guide completely before installing or programming your new controller.

TABLE OF CONTENTS

Features	<i>i</i>
Controller Components	2-3
General Information	4-6
How the Backup System Works.....	4
How the Electronic Circuit Breaker Works.....	5
How the Sensor Feature Works	6
Programming the Controller	7-15
Getting Started.....	7-9
Setting the Current Time and Date.....	10
Erasing Any Prior Programs	11
Setting the Station Run Time.....	11
Master Valve/Pump Start On/Off	12
Setting Program Start Times.....	12-13
Selecting the Days to Water	13-15
Operating the Controller	15-18
% Season Adjust	15
Manual Operations.....	16-17
Off and Rain Delay	17-18
Installation Procedures	19-24
Selecting an Installation Site.....	19
Mounting the Controller	20
Installing Electrical Conduit.....	20
Connecting Valve Wiring.....	21
Connecting an Optional Pump Start Relay	22
Connecting an Optional Rain Switch Sensor.....	23
Connecting an Earth Ground.....	23
Connecting the Power Wires.....	24
Appendix A - Troubleshooting	25-26
Appendix B - Fuse Replacement	27
Appendix C - Specifications	28
Warranty	29

CONTROLLER COMPONENTS

▲ FIGURE 1

- 1 **LCD Display:** For viewing time, program and status information.
- 2 **+ /On & - /Off Buttons:** For entry of program information.
- 3 **Next Button:** For selection of information to be programmed or reviewed.
- 4 **Function Dial:** For selecting the programming and operating functions.
- 5 **Current Time & Date:** For setting the current time and date.
- 6 **Station Times:** For setting individual watering time for each station.
- 7 **Program Select Switch:** For selection of programs A, B, C or D.
- 8 **Program Start Times:** For setting the time each program cycle will start.
- 9 **Watering Days:** For setting a watering day schedule for each program.
- 10 **% Season Adjust:** For the increase or decrease of station times for all stations within a program without changing program memory.
- 11 **Program Erase:** For erasing information within a selected program.
- 12 **Sensor Control Switch:** To override rain switch sensor input.
- 13 **Manual Program Cycle:** For manual operation start of a selected program watering cycle.
- 14 **Manual Single Station:** For timed or untimed operation of a single station.
- 15 **Off / Rain Delay:** For immediate shut down of all controller output. Programmable output delay for 1–7 days (Rain Delay).
- 16 **Run:** For automatic operation.

▲ FIGURE 2

- 17 **Safety Fuse:** Replaceable 2.0A slow-blow fuse provides protection from an internal short-circuit condition.
- 18 **Sensor Connection Terminals:** For the connection an optional (normally-closed) rain switch device.
- 19 **Earth Ground Lug:** For connection of a 12–16 (2.0–1.0mm²) gauge copper ground wire.
- 20 **1/2" NPT Conduit Nipple:** For the connection of an electrical conduit access body for 120 V a.c. power wiring.
- 21 **(Inset) Terminal Strip:** For the connection of 220/240 V a.c. power wiring. (Export models only.)
- 22 **Valve Common Terminals:** For the connection of up to three field (24V) common wires.
- 23 **Valve Wire Terminals:** For the connection of valve control wires.
- 24 **Master Valve Terminal:** For the connection of a master valve or pump start relay control wire.
- 25 **Battery Compartment:** 9-volt alkaline battery access compartment.

Figure 1

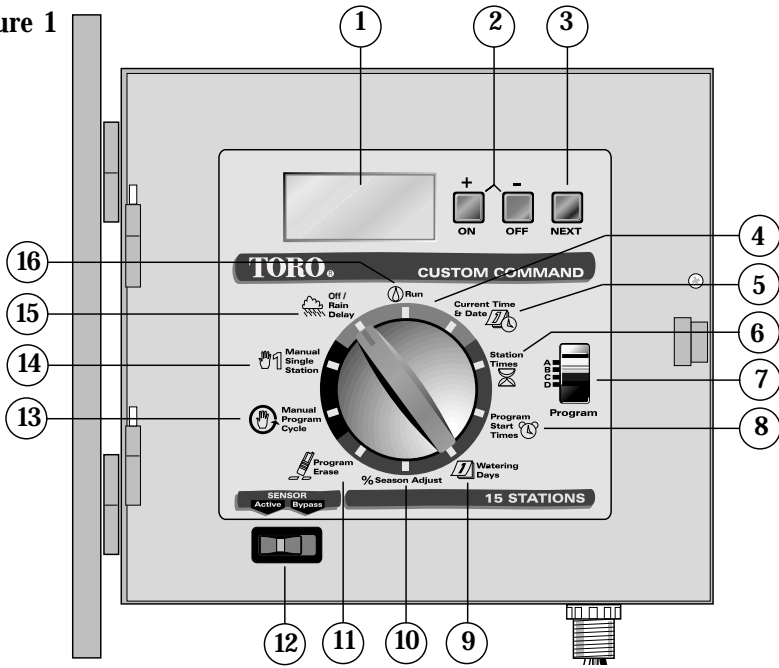
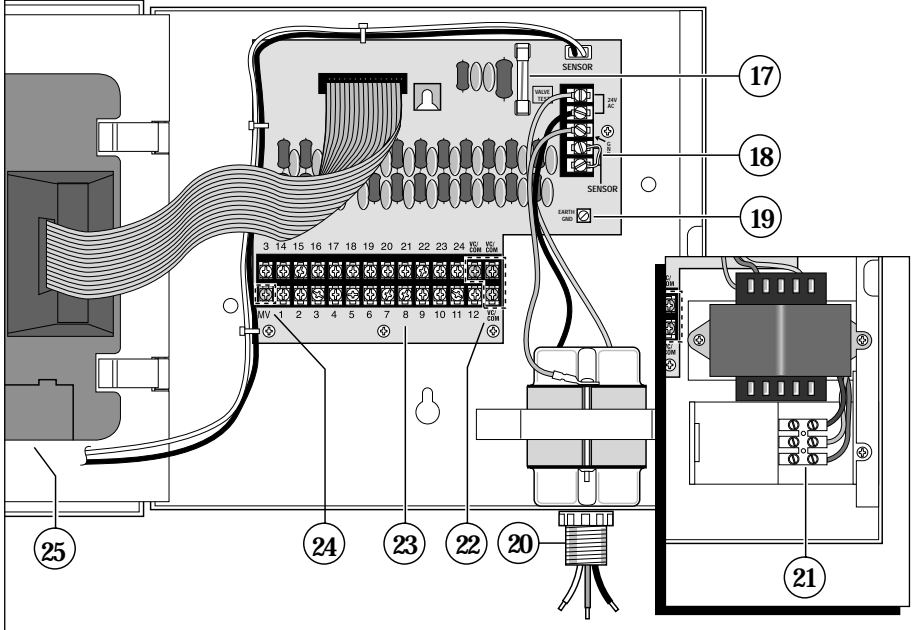

Figure 2



Controller Components

GENERAL INFORMATION

This section contains general information on:

- How the backup system works
- How the electronic circuit breaker works
- How the sensor feature works

HOW THE BACKUP SYSTEM WORKS

The Custom Command uses non-volatile memory to store watering programs. This type of memory prevents the watering program information from becoming lost in the event of a power failure. An additional benefit of non-volatile memory is that a factory-installed backup program is not necessary, thereby avoiding the potential for dead-heading a pump.

Because the current time and date are always changing, only the most recent date can be saved in non-volatile memory. Therefore, a battery is required to maintain the correct time and date in the event of a power failure. A 9-volt alkaline battery (provided) will maintain the correct time and date during power failures up to 90 days. In a typical installation, the battery should last from two to four years before replacement is necessary. Once the battery or AC power is connected, the controller can be fully programmed for operation.

Note: For operation of the valves, AC power must be applied.

To install the battery:

1. Remove the screw from the hinged control module assembly and carefully swing it outward to open.
2. Locate and remove the battery compartment cover from the lower back side of the module.
3. Connect the 9-volt alkaline battery supplied to the battery clip terminals.
4. Insert the battery into the compartment and reinstall the battery compartment cover.

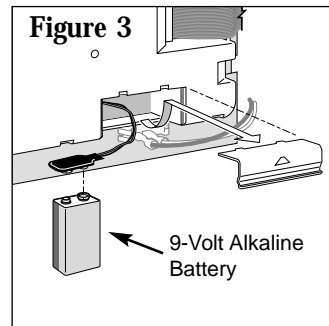

Caution: Batteries contain hazardous material. Always handle and discard batteries properly in accordance with the battery manufacturer's recommendations.

HOW THE ELECTRONIC CIRCUIT BREAKER WORKS

The controller is equipped with an electronic circuit breaker. If the controller detects a short circuit, the shorted station (valve) will be turned off automatically. The display will then flash "SHORT" and the shorted station number or "MASTER VALVE." The controller continues to automatically water the other stations and the following watering programs until the shorted station is repaired. The program will be cancelled if the master valve circuit is shorted. Each automatic start will attempt another cycle and retest the short-circuited valve. Listed below are the most common conditions which will activate the electronic circuit breaker. After correcting the problem, return the controller to normal operation as follows:

1. Set the dial to one of the following positions: **Run, Manual-Single Station or Manual-Program Cycle.**
2. Press the **OFF** button to return the controller to the normal operating mode.

Condition: The word "SHORT" displays with one or more station numbers.

Diagnosis: One or more stations are shorted.

Solution: Check the wiring of the displayed stations for the cause of the shorted condition. Repair valve(s) and/or wiring as needed.

Diagnosis: Too many valves operating at the same time causing an overload condition.

Solution: Check watering programs for concurrent station operation. Include master valve/pump start relay if used. Maximum total output is 24 V a.c. at 1.25 amps. Reduce the number of stations running at the same time.

Condition: The word "SHORT" displays without any station numbers.

Diagnosis: A short circuit has occurred with a time duration too short for the controller to determine the station.

Solution: Check all valve wiring for breaks in the insulation which may cause a station output to short to common.

Diagnosis: A transient power surge spike has occurred.

Solution: Reset the controller.

Diagnosis: A short or overload occurred on one watering cycle but was no longer there on a subsequent cycle.

Solution: Check for loose and/or exposed valve wiring.

HOW THE SENSOR FEATURE WORKS

The Custom Command is equipped to operate with an optional rain sensing device, commonly called a “Rain Switch,” to prevent automatic watering during rain.

The rain switch is a simple device, typically installed on a roof overhang or stationary structure exposed to rainfall and full sun, and shielded from irrigation spray.

When rain occurs, the normally closed rain switch senses the moisture and opens the valve common circuit, effectively preventing all output to the field. The electronic programming portion of the controller is isolated from the rain sensor switch, and continues to operate as programmed. When rain stops and the rain switch returns to its normally closed state, the valve common circuit is restored, enabling watering to resume as scheduled.

A two-position Sensor switch (see item 19 on page 3) is provided to enable you to easily bypass operation of the rain switch at any time. If you choose to disregard rain switch input, place the **SENSOR** switch in the **Bypass** position. To enable rain switch operation, place the Sensor switch in the **Active** position.

Note: A jumper wire is installed across the sensor terminals. The jumper must be removed when the rain switch wires are connected.

PROGRAMMING THE CONTROLLER

This section covers the following topics:

- Getting started
- Setting the current time and date
- Erasing any prior programs
- Setting the station run time
- Selecting Master Valve/Pump Start on/off
- Setting the program start times
- Selecting the days to water

GETTING STARTED

The unique modular design of the Custom Command enables you to easily remove the control module from the cabinet and take it anywhere for handy programming– even to your favorite easy chair! Just swing the module out, unplug the cables, then lift the module from its hinges. Now, by installing a 9-volt alkaline battery you can program and review your watering schedules and have it ready to operate upon completion of the installation. (See battery installation instructions on page 4.)

Note: To extend battery life, the display will automatically dim after two minutes of inactivity. To restore the display, simply turn the function dial to any position.

WHAT IS A WATERING PROGRAM?

In basic terms, a watering program is a small set of instructions which tells the controller when to start a watering cycle, which stations will operate during the cycle, which days the cycle will be active and how long each station will operate during the cycle. The Custom Command has four independent watering programs for your use. Separate programs are usually used to group stations with similar watering requirements. For example, you might use one program to water lawns in full sun every day. Another program could be used to water lawns in partial shade only on Monday, Wednesday and Friday. Trees and shrubs using drip irrigation could run on a separate program once every two weeks. The garden area requirements might include watering every other day. As you can see, the availability of four programs allows you to have unique watering programs for your varied landscape needs.

WHAT IS A PROGRAM WATERING CYCLE?

When a watering start time is selected, that time becomes the beginning of an automatic watering cycle. A watering cycle operates each station assigned to the program, one by one, in numerical order. When setting up watering schedules, it is important to remember that start times are assigned to programs, not individual stations.

In the following example, (also shown on the sample watering plan on page 9) we have set up Program A to start at 2:00 a.m. and again at 3:00 a.m. on a 1-day interval (every day). Stations 1, 2, 4 and 5 are front and back yard lawn areas which get full sun throughout the day. These stations will run for 10 minutes each for a total of 20 minutes run time per day. Stations 3, 6 and 7 are lawn areas which are shaded during the afternoon hours. These areas require less water, so we have assigned them to Program B and set them to run for 20 minutes on a 2-day interval (every other day).

At 2:00 a.m., Program A watering cycle starts. Station 1 turns on, runs for 10 minutes, and shuts off. Station 2 turns on, runs for 10 minutes, and shuts off. Stations 4 and 5 operate sequentially in the same manner, each running for their set run time. When Station 5 shuts off, the watering cycle is completed for the first start time. At 3:00 a.m., the watering cycle starts again and repeats the same station-by-station watering sequence.

Note that we have 40 minutes total watering time per cycle in Program A. If we had set the next start time at 2:30 a.m., the start time would have been delayed until 2:40 a.m., enabling the first cycle to finish as programmed. This function is called “start time stacking”, and can occur within each program.

Watering programs, however, operate independently, which means that two or more programs can run simultaneously. In our example, Program B will also start at 2:00 a.m. Therefore, Stations 1 and 3 will turn on at the same time, and Station 2 will turn on while Station 3 is running. This feature enables more watering to be completed within the prime “watering window”, which is generally between Midnight and 6:00 a.m.

Note: When scheduling watering programs to run simultaneously, it is important to ensure the water supply has sufficient pressure and volume to maintain optimum sprinkler performance.

WATERING SCHEDULE FORM (SAMPLE)



For your convenience, a Watering Schedule Form/Quick Reference Card is provided. Use the form to plan and record your automatic watering activities. Use the quick reference instructions when minor programming changes are required. Keep the card with the controller by attaching it to the inside front cover

(Example)

Watering Schedule Form		Program A	Program B	Program C	Program D
Watering Day Schedule	Week Days				
	Odd/Even				
	Interval	1	2		
Watering Cycle Start Times		2 am, 3 am	2 am		
Station	Station Description	Station Run Time			
1	Front Lawn (sun)	10 min			
2	Front Lawn (sun)	10 min			
3	Side Lawn (shade)		20 min		
4	Back Lawn (sun)	10 min			
5	Back Lawn (sun)	10 min			
6	Back Lawn (shade)		20 min		
7	Back Lawn (shade)		20 min		
8					
9					
10					
11					
12					
13					
14					
15					
16					
17					
18					
19					
20					
21					
22					
23					
24					

SETTING THE CURRENT TIME AND DATE

Before you can program the controller for automatic watering, you must set the controller clock to the current time and date. This controller features a 365-day calendar with automatic leap year compensation. Once the date is set, the controller keeps track of the date and enables trouble-free, odd-even day of the month watering required in some locations. The time and date apply to all programs. To set the time and date, follow the steps below.

1. Turn the Function Dial to the **Current Time & Date**  position. The Hour digits and AM/PM will flash.
2. Press the + button to increase or – button to decrease the hour digit.
Note: Continuous pressure on the + or – buttons, causes the display to change rapidly.
3. Press the **NEXT** button to select the minutes digits.
Use the + and/or – buttons to set the current minute.
4. Press the **NEXT** button to select the year digits.
Use the + and/or – buttons to set the current year.
5. Press the **NEXT** button to select the month.
Use the + and/or – buttons to set the current month.
6. Press the **NEXT** button to select the day digit(s).
Use the + and/or – buttons to set the current calendar day.
7. Return the Function Dial to the **Run**  position when the current time and date have been set.

ERASING ANY PRIOR PROGRAMS

This process enables you to easily clear the controller memory of all user-defined watering program information within an individual program. This is an optional procedure and can be skipped if you wish to retain previous program operating information or the controller has not yet been programmed.

Erasing a program resets the memory to factory conditions: No station run time, program start time or active watering days. Season Adjust is set to 100% and Master Valve/Pump Start is set to be “On”.

Note: This process is program independent and resets only the information for the selected program.

To erase program information for a selected program:

1. Select Program A, B, C or D with the Program switch.
2. Turn the function dial to the Program Erase  position. The display will show “ERASE”.
3. Press and hold the OFF button until “DONE” is displayed.
4. Repeat this procedure for each program you wish to erase.

SETTING THE STATION RUN TIME

A station is assigned to a program when it is given a station run time (from 1 minute to 10 hours) in that program. The station can have only one run time per program. Additionally, the station can be assigned to any number of programs and have a different run time assigned in each.

To set the run time for each station:

1. Turn the function dial to the Station Times  position. The controller displays STATION NUMBER 1 and OFF (or the current station run time).
2. Select Program A, B, C or D with the Program switch.
3. Press the NEXT button to select the station number you wish to set (if other than the one displayed).
4. Use the + and/or – buttons to display the desired station run time.

Note: OFF is the factory setting for each station. If the station has a run time and you wish to remove it from this program, use the + and/or – buttons to select OFF, (displayed between 10:00 [ten hours] and 00:01 [one minute]). (CONTINUED)

5. Repeat steps 3 and 4 to set a run time for each station you wish to assign to the selected program.
6. Repeat steps 2 through 5 for each program as necessary.

MASTER VALVE/PUMP START ON/OFF

The Custom Command enables automatic operation of the Master Valve/Pump Start output circuit to be controlled independently for each watering program. For example, if a program is used for drip irrigation and the system pump is not required, the Master Valve/Pump Start output circuit can be shut off whenever that program begins operation.

The factory setting is ON for each program. Use the steps below to select the operation of this feature for each program as necessary.

1. Turn the function dial to the **Station Times**  position.
2. Select Program A, B, C or D with the **Program** switch.
3. Press the **NEXT** button repeatedly until **MASTER VALVE** is displayed.
4. Press the **OFF** or **ON** button to display the operation of the master valve/pump start output for the selected program.
5. Repeat steps 2 through 4 for each program as necessary.

SETTING PROGRAM START TIME(S)

This procedure is used to set the watering cycle start time(s) for each program. A maximum of 16 start times can be allocated to the four programs in any manner. Each start time will initiate a sequential watering cycle of all stations with an assigned run time in the program.

Note: When 16 start times have been allocated, the display will show **NONE REMAINING** when attempting to assign additional start times.

To set program cycle start time(s):

1. Turn the function dial to the **Program Start Times**  position.
2. Select Program A, B, C or D with the **Program** switch.
3. Use the + and/or – buttons to display the start time.

Note: To remove a start time, adjust the time to display **OFF** (located between 11:59 p.m. and 12:00 a.m.).
4. Press the **NEXT** button to assign another start time to the program.
5. Repeat steps 2 through 4 for each program as necessary.

Note: The Custom Command will operate one watering cycle in a program at a time. If a start time occurs while a watering cycle is in progress, the start time will be delayed until the previous cycle is finished (this is called “start time stacking”). If the watering cycle extends past midnight into the next day, the cycle will continue operating until finished. However, if a watering cycle has been delayed until after midnight into a non-watering day, the watering cycle will not occur.

SELECTING THE DAYS TO WATER

Several watering day scheduling options are available. Each watering program can utilize any ONE of the following schedules:

- **Days of the week**

Use this type of schedule to water on specific days of the week. The days are displayed as three-letter abbreviations. For example, Sunday is SUN, Monday is MON, etc. Only the days you select to water will remain on the display.

- **Odd Days or Even Days**

To select every odd or even number calendar day, use this option. Because the 31st and the 1st are both odd number days, the 31st is automatically removed from the schedule. This watering day option also enables selected days of the week to be removed from the schedule.

- **Day Interval**

Selecting watering days by Day Interval enables a specific number of days between watering to be selected. For example, selecting a 1-day Interval schedules watering for every day. A 2-day interval schedules watering for every other day. A 30-day interval is the maximum interval frequency, which provides watering once every 30 days.

Another setting within the Day Interval is the current day of the schedule. The current day (displayed as TODAY) can be set for any day within the interval. This number automatically increases by one every day. When the TODAY number equals the Day Interval number, a watering day will occur. For example, to water every third day starting today, a 3-day interval would be set with TODAY as day 3. Or, to water every 5 days starting tomorrow, a 5-day interval would be selected with TODAY as day 4.

To set a watering day schedule for each program:

1. Turn the function dial to the **Watering Days**  position. The display will show the current watering day schedule for the selected program.
2. Select Program **A**, **B**, **C** or **D** with the **Program** switch.
3. Set the watering day(s) for the program using one of the three following procedures: **Days of the Week**, **Odd Days/Even Days** or **Day Interval** scheduling procedure.
4. Repeat steps 2 and 3 as necessary to set a watering day schedule for each program.

Days of the Week

- A. Press the **NEXT** button until the weekday abbreviations are shown at the top of the display.
- B. Press the **ON** button. SUN (Sunday) will begin flashing.
- C. To select the day, press the **ON** button. To remove the day from the schedule, press the **OFF** button.
- D. Press the **NEXT** button to select the next day.
- E. Repeat steps C and D to set the remaining days of the week.

Odd Days or Even Days

- A. Press the **NEXT** button until **ODD DAYS** or **EVEN DAYS** is displayed.
- B. Press the **ON** button to select the schedule.
Optional: To remove selected days of the week from the Odd/Even watering schedule:
 1. Press the **NEXT** button until the selected day begins flashing.
 2. Press the **OFF** button to exclude the day from the schedule. (Press the **ON** button to restore the day to the schedule.)

Day Interval

- A. Press the **NEXT** button until the **DAY INTERVAL** option is displayed.
- B. Press the **ON** button to select this option.
- C. Press the **NEXT** button. The display shows the current Day Interval number (1–30).

- D. Use the + or – button to select the Day Interval (1–30 days).
- E. Press the NEXT button. The controller displays TODAY and its current setting.
- F. Use the + or – button to select the desired setting for today.

OPERATING THE CONTROLLER

This section includes instructions for the following controller operations:

- % Season Adjust
- Manual Operations
- Off and Rain Delay Modes

% SEASON ADJUST

The % Season Adjust feature enables you to easily increase or decrease the station run time (by percentage) of all stations assigned to a selected program. This is handy for making temporary, overall station run time adjustments without changing the original run time settings. % Season Adjust values range from 0 to 200% in 10% increments, with 100% being the normal setting.

For example, as the fall season approaches and the temperature decreases, you may want to reduce the station time for the stations in program A by 30%. Later you can return station times to their original values by setting the % Season Adjust value back to 100%.

Note: It is possible to inadvertently cause start time stacking when increasing station run time. Careful planning and use of % Season Adjust will prevent this from happening.

To change the % Season Adjust percentage value of a selected program:

1. Turn the function dial to the % Season Adjust position.
2. Select Program A, B, C or D with the Program switch.
3. Use the + and/or – buttons to increase or decrease the percentage value (0–200%).
4. Turn the function dial to the Run  position.

Note: The controller displays the % symbol in the Run  position when % Season Adjust is in use for any program. During operation, the adjusted run time will be displayed.

MANUAL OPERATIONS

Manual operation allows you to run individual stations or start automatic watering programs as needed. The Custom Command provides separate dial positions for each type of operation: Single Station and Program Cycle.

SINGLE STATION

This option enables individual stations to be operated for an untimed duration (turned On/Off) or operated for a selectable duration from one minute to 10 hours.

1. Turn the function dial to the **Manual Single Station**  position.
2. Select Program A, B, C or D with the **Program** switch.



Note: The programmed status of the master valve/pump start in the selected program determines whether the master valve/pump start will be activated with the manual operation.

3. Use one of the following options to operate the station.

For untimed operation:

- A. Press the **NEXT** button as necessary to display the station you wish to operate.
- B. Press the **ON** button. The station will turn on and remain on until one of the following occurs:
 - The **OFF** button is pressed
 - The controller clock passes midnight
 - The function dial is moved to another position

For timed operation:

- A. Press the **NEXT** button as necessary to display a station you wish to operate.
- B. Use the **+** and/or **-** buttons to set the desired amount of station run time (for this operation only), from one minute to 10 hours.
- C. To select additional stations to operate in sequence, repeat steps A and B as desired. Each station will operate one-by-one in the order they were selected.
- D. Leave the function dial in the **Manual Single Station**  position until the manual operation is complete, then return the dial to the **Run**  position.



PROGRAM CYCLE

Use this feature to manually operate watering programs. You can run the entire program or start anywhere within the station sequence of the program.

Note: Only the stations with an assigned run time in the program will operate during the program watering cycle.

1. Turn the function dial to the **Manual Program Cycle**  position.
2. Select Program A, B, C or D with the **Program** switch.
3. Press the **NEXT** button to select the first station of the watering sequence (if other than the station number displayed).
4. Press the **ON** button to start the watering cycle. Watering will start with the selected station and will be followed by all subsequent stations. The display will show the run time remaining for the operating station.



Note: You may advance through the stations by pressing the **NEXT** key for the next station. To terminate operation at any time, press the **OFF** button.

5. Leave the function dial in the **Manual Program Cycle**  position until the manual operation is complete, then return the dial to the **Run**  position.

OFF AND RAIN DELAY

Use this feature to turn off controller operation for indefinite periods of time (Off mode) or for a selected number of days (Rain Delay mode).

Turning Off the Controller



Turning the function dial to the **Off / Rain Delay**  position places the controller in the Off mode. After a 2-second delay, any current watering activity will shut off and all subsequent watering program activity will be suspended. As long as the function dial is in the **Off / Rain Delay**  position, the controller will remain in the Off mode. The controller clock continues to update current time and date, and all watering program information is retained while in the Off mode. Normal controller operation is resumed by simply placing the function dial in any other position.

Using the Rain Delay Mode

The Rain Delay mode enables automatic watering to be delayed from 1 to 7 days. At the end of the selected delay period, the controller resumes automatic operation. (CONTINUED)

Operating the Controller



To set a Rain Delay period

1. Turn the function dial to the **Off / Rain Delay**  position.
2. Use the + and/or – buttons to select the number of days (1–7) to delay operation.
3. Turn the function dial to the **Run**  position.

The display will show the number of days remaining in the delay period. The day number will automatically decrease by one digit each time the clock passes midnight. Automatic operation resumes when the display shows no delay days remaining.

Note: The controller can be operated manually while in the Rain Delay mode.

To cancel the Rain Delay mode:

1. Turn the function dial to the **Off / Rain Delay**  position.
2. Press the – button until the display shows no delay days remaining.
3. Turn the function dial to the **Run**  position.

INSTALLATION PROCEDURES

This section includes instructions for mounting the controller cabinet and making the necessary wiring connections. To ensure safe operation, it is important to follow the instructions carefully. The following procedures include:

- Selecting an Installation Site
- Mounting the Controller
- Installing Electrical Conduit
- Connecting the Valve Wiring
- Connecting an Optional Pump Start Relay
- Connecting an Optional Rain Switch Sensor
- Connecting an Earth Ground
- Connecting the Power Wires

SELECTING AN INSTALLATION SITE

Selecting the proper installation site for the controller is essential to safe and reliable operation. The Custom Command features a weather resistant cabinet designed for indoor or outdoor installation.

For easy operation and better view of the display, install the controller so that the display is at, or slightly below eye level.

The controller should be installed on a vertical wall or other sturdy structure near a grounded power source. Select a location that shades the controller during the hottest hours of the day and provides as much protection from direct sunlight, rain, wind and snow as possible. DO NOT mount the controller where it will be exposed to direct spray from the irrigation system.

MOUNTING THE CONTROLLER

1. Place the mounting template (provided) on the wall, positioning the controller display area at or slightly below eye level. Using a small punch or nail, mark the locations of the top and bottom centerline mounting holes and the additional lower holes if extra cabinet support is desired. (Only two mounting screws are provided.)
2. Drill pilot holes at least 1-1/4" (32mm) deep into the wall using a 3/32" (2.5mm) drill for wall stud, or 1/4" (6.5mm) drill for masonry.
3. For the masonry wall installation only, insert the plastic screw anchors (provided) into the pilot holes.

Optional: The door and control module can be easily removed from the cabinet to simplify installation. To do this, unplug the ribbon cable connector from the control module and the two push-on wire connectors from the bypass switch. Lift the cover and control module up and off the hinge pins.

4. Place a small plastic washer and a rubber washer on each screw. Install the #10 screws into the top and bottom locations leaving the screw head about 1/2" (13mm) from the wall.
Note: If installing additional lower mounting screws, remove plastic hole plugs at this time.
5. Hang the cabinet on the screws using the keyhole slots. Ensure the screws engage the slotted portion of the keyhole with the plastic washer positioned between the screw head and the inner cabinet wall. Tighten the screws securely. Install additional screws in the lower left and/or right mounting holes as required.

INSTALLING ELECTRICAL CONDUIT

Note: Electrical conduit and adapters are not supplied with the controller but may be required for installation in your area. Check local electrical codes and install conduit according to requirements.

1. For power wires, install a 1/2" NPT threaded conduit access body to the transformer assembly threaded nipple. From the access body, install conduit to the source point of connection. (Domestic and international models only.)
2. For field (low voltage) wiring, install a 2" (52mm) conduit adapter and conduit.

CONNECTING THE VALVE WIRING

1. To provide a field common wire, attach one wire to either solenoid lead of all sprinkler valves and master valve (optional).
2. Attach a separate control wire to the remaining solenoid lead of each valve. Label the control wires with the intended station number for identification at the controller.



Caution: All wiring splices must be waterproofed to prevent short circuits and corrosion.

A maximum load of 12 VA (0.5 amps) may be connected to each station. A maximum load (including master valve) of 30 VA (1.25 amps) may be programmed to operate simultaneously. Exceeding these limits can damage the controller.

3. Route the control and common wires into the controller cabinet through the 2" (52mm) access opening. Remove approximately 1/2" (13mm) insulation from the ends of each wire.
4. Attach the field common wire to one of the three valve common terminals labeled VC/COM.
5. Referring to **Figure 4**, connect each valve control wire to the appropriate station number terminal. If an optional master valve is installed, connect its control wire to the terminal labeled MV/PUMP. Tighten all terminal screws securely.

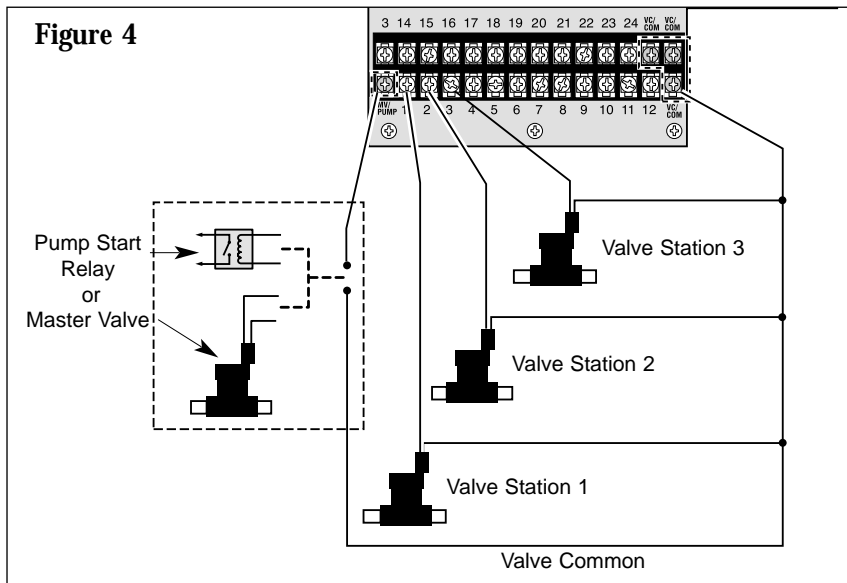

CONNECTING A PUMP START RELAY

When a pump is to be operated by the controller, a compatible relay must be used. The relay coil will be connected to the master valve (MV) terminal and must be rated for 24 V a.c. at 0.5A maximum. The relay contacts will be connected to the pump start terminals and must be rated for use with the particular pump.

Note: Transient suppressors may be needed across the relay contacts in installations using large pumps.

Caution: Do not connect the master valve output terminal directly to the pump start terminals. This will damage the controller.

To connect the pump start relay:

1. Connect the master valve output terminal (MV) to one side of the relay coil.
2. Connect the other side of the relay coil to the valve common (VC) terminal. See **Figures 4 and 5**.

WARNING



Proper connection of the pump and relay contacts depends on the pump configuration and may involve HIGH VOLTAGE. This connection should be performed by a licensed electrical contractor in accordance with all requirements of the National Electrical Code, applicable state and local codes and the pump manufacturer's recommendations.

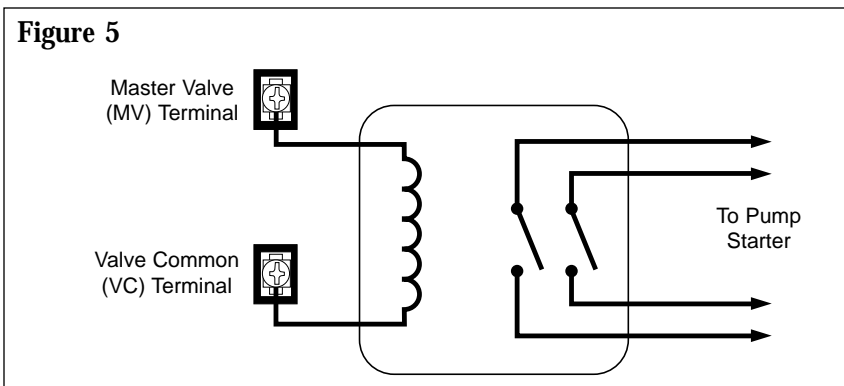

CONNECTING A RAIN SWITCH SENSOR

The Custom Command is designed for use with a normally closed rain sensor or “Rain Switch.” (Refer to page 6 for additional important rain switch information.)

To connect the rain switch sensor:

1. Route the two wires from the sensor into the cabinet through the field wire access opening.
2. Connect the wires to the “SENSOR” terminals in either order. See **Figure 6**.

Note: Refer to the installation instructions provided with the sensor for additional information.

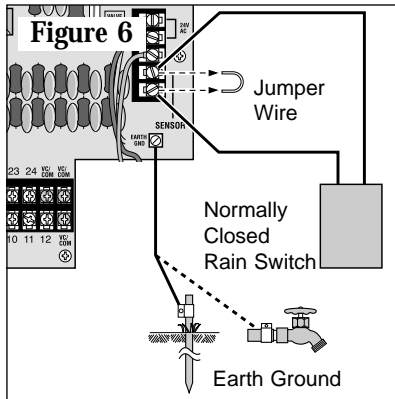

CONNECTING AN EARTH GROUND

A power surge is a sudden rise in voltage on the power main line. It is then often followed by a drop in voltage as the power line equipment tries to protect area users. A lightning strike on the power grid is the most common cause of power surges and can be damaging to the controller. *Surge protection is built into the Custom Command PC board to reduce the potential for surge damage by shunting the voltage to earth ground. Therefore, an important step in the installation process is to properly connect the controller to an earth ground source, especially if the controller is located in a lightning-prone area.

***Note:** The Custom Command international units are manufactured without output surge protection. If output surge protection is required, contact your local Toro dealer for assistance.

▲ Caution: The built in surge protection components cannot effectively protect the controller circuitry from power surge unless properly connected to an earth ground source.

To connect an earth ground:

1. Route a 12–16 gauge (2.0–1.0mm²) solid copper wire in the shortest and most direct path from the “EARTH GND” Ⓧ lug, located on the controller’s terminal board (see page 3, item 19) to an earth ground source such as metal (not plastic) water pipe or copper-clad ground rod. See **Figure 6**.
2. Clamp the bare wire securely to the pipe or ground rod. Make sure the wire contact area is free of dirt and corrosion.

CONNECTING THE POWER WIRES

⚠ WARNING: All electrical components must meet applicable national and local electrical codes including installation by qualified personnel. These codes may require an external junction box mounted on the transformer nipple (domestic model) and a means in the fixed wiring of disconnecting AC power having a contact separation of at least 0.120" (3mm) in the line and neutral poles. Ensure the AC power source is OFF prior to connecting to the controller. The wire used for connection to the controller must have insulation rated at 105°C minimum.

⚠ Caution: Do not connect the controller to one phase of a three-phase power supply used by a pump or other electrical equipment.

1. Ensure the power is disconnected at the source.
2. Route the AC power and equipment ground wires through electrical conduit to the controller.
3. For 120 V a.c. models: Attach the Hot to the Black wire, Neutral to the White wire and Equipment Ground to the Green or wire. Properly insulate all wire connections. See Figure 7A. Close and secure the conduit body cover.
- For 220/230 V a.c models: Remove the cover plate installed directly below the transformer. Using a small flat blade screwdriver, secure AC mains to the terminal block as follows: Line 1 to "L", Line 2 to "N" and Equipment Ground to \oplus . See Figure 7B. Reinstall the cover plate.

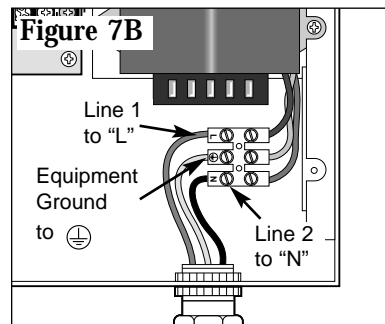
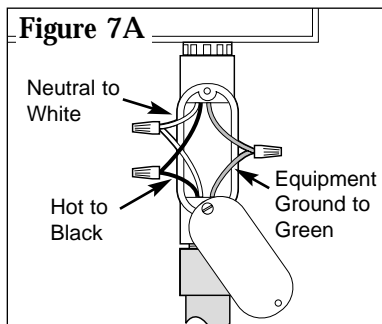

4. Apply power to the controller.

Appendix A

TROUBLESHOOTING

❖ Error	Solution
❖ All valves will not turn on automatically	<ol style="list-style-type: none">1. Verify program: station time, watering start times, watering days schedule, current time, current day, water budget and rain delay.2. Check valve common wire for proper connection.3. Check for a shorted station; refer to “How the electronic circuit breaker works” on page 5.5. Ensure rain sensor (if installed) is properly connected and functioning properly. If rain sensor is not installed, ensure the SENSOR SWITCH is in BYPASS position.6. Check fuse, replace if necessary. See p. 27.
❖ Cannot program	<ol style="list-style-type: none">1. Disconnect power to controller for 1 minute. Reconnect power and reprogram.2. Install fresh 9-volt alkaline battery.3. Verify that all 16 start times are not in use by other programs.
❖ Controller skips a cycle	<ol style="list-style-type: none">1. Verify watering start times, current time and watering days schedule.
❖ No display	<ol style="list-style-type: none">1. Check power source for tripped circuit breaker.2. If control module has been removed, this is a normal battery-saving feature. Turn dial to any position to reactivate display.3. Disconnect power to controller for 1 minute. Reconnect power and reprogram.4. Replace battery5. Check fuse, replace if necessary. See p. 27.

❖ Error	Solution
❖ Valve stays on	<ol style="list-style-type: none"> 1. Check station times and water budget. 2. Check for Manual mode; place dial in the Run position. 3. Disconnect valve wire. If still on, valve malfunction is indicated. 4. Check for manual bleed closure at valve.
❖ Valve will not turn on	<ol style="list-style-type: none"> 1. Ensure dial is not in Off / Rain Delay position or Rain Delay mode active. 2. Verify program: station time, watering start times, watering days schedule, current time, current day and water budget. 3. Make sure common wire and valve wire are correctly connected. 4. Check for a shorted station, refer to page 5. 5. If using sensor, check sensor. 6. Check for blown fuse. Replace if necessary. See page 27 for fuse replacement information.
❖ “Short” or “Master Valve” is displayed	<ol style="list-style-type: none"> 1. See “How the Electronic Circuit Breaker Works” on page 5 for troubleshooting information.
❖ Waters too often	<ol style="list-style-type: none"> 1. Too many program start times set. Check each program to determine the number of start times assigned and remove as necessary.

Appendix B

FUSE REPLACEMENT



WARNING

If fuse replacement is required, replace only with the same type and rating. Installing a higher amperage fuse can result in serious injury and or equipment damage due to fire hazard. Ensure power to controller is off prior to removing or installing fuse.

1. Disconnect power to the controller.
2. Locate fuse (see page 3, item 17) and carefully remove it from the retaining clips.
3. Locate the replacement fuse supplied in the mounting hardware accessory bag. Install the new 2.0A slow-blow fuse, ensuring it is securely seated in the retaining clips.
4. Restore power to the controller.

Appendix C

SPECIFICATIONS

Cabinet:

Metal, weather-resistant, indoor/outdoor, wall mount with key-actuated locking cover

Dimensions:

10.75" W x 9.5" H x 5.75" D
(27.3cm W x 24.1cm H x 14.6cm D)

Wiring/Conduit Provision:

Power Wiring - 1/2" NPT end bell nipple

Field Wiring - 2" (52mm) diameter conduit access

Power Specifications, Domestic Model:

Input – 120 V a.c., 60 Hz, 0.5A

Output – 24 V a.c., 60 Hz, 30 VA (max. total), 0.5A (max. per station)

Power Specifications, International Model:

Input – 230 V a.c., 50 Hz, 0.5A

Output – 24 V a.c., 50 Hz, 30 VA (max. total), 0.5A (max. per station)

Power Specifications, Australian Model:

Input – 240 V a.c., 50 Hz, 0.5A

Output – 24 V a.c., 50 Hz, 30 VA (max. total), 0.5A (max. per station)

Sensor Input: Normally-closed rain switch (override switch provided)

Master Valve/Pump Start Relay Output: 24 V a.c., 0.5A (maximum)

Battery: 9-volt, Alkaline

Fuse: 250V, 2.0A, Slow-Blow (extra fuse provided)

Temperature Limit Specifications:

Operating – 32°F to 140°F (0°C to 60°C)

Storage – -22°F to 149°F (-30°C to 65°C)

Warranty

The Toro Promise — Limited Five-Year Warranty

The Toro Company and its affiliate, Toro Warranty Company, pursuant to an agreement between them, jointly warrants, to the owner, each new piece of equipment (featured in the current catalog at date of installation) against defects in material and workmanship for for a period described below, provided they are used for irrigation purposes under manufacturer's recommended specifications. Product failures due to acts of God (i.e., lightning, flooding, etc.) are not covered by this warranty.

Neither Toro nor Toro Warranty Company is liable for failure of products not manufactured by them even though such products may be sold or used in conjunction with Toro products.

During such warranty period, we will repair or replace, at our option, any part found to be defective. Your remedy is limited solely to the replacement or repair of defective parts.

Return the defective part to your local Toro distributor, who may be listed in your telephone directory Yellow Pages under "Irrigation Supplies" or "Sprinkler Systems," or contact The Toro Warranty Company P.O. Box 489, Riverside, California, 92502. Phone (800) 664-4740 for the location of your nearest Toro distributor or outside the U.S., call (909) 688-9221.

This warranty does not apply where equipment is used, or installation is performed, in any manner contrary to Toro's specifications and instructions, nor where equipment is altered or modified.

Neither Toro nor Toro Warranty Company is liable for indirect, incidental or consequential damages in connection with the use of equipment, including but not limited to: vegetation loss, the cost of substitute equipment or services required during periods of malfunction or resulting non-use, property damage or personal injury resulting from installer's actions, whether negligent or otherwise.

Some states do not allow the exclusion or limitation of incidental or consequential damages, so the above limitation or exclusion may not apply to you.

All implied warranties, including those of merchantability and fitness for use, are limited to the duration of this express warranty.

Some states do not allow limitations of how long an implied warranty lasts, so the above limitation may not apply to you.

This warranty gives you specific legal rights and you may have other rights which vary from state to state.

The Custom Command series controllers are covered by this warranty for a period of five years from the date of installation.

Electromagnetic Compatibility

Domestic: This equipment generates and uses radio frequency energy and if not installed and used properly, that is, in strict accordance with the manufacturer's instructions, may cause interference to radio and television reception. It has been type tested and found to comply with the limits for a FCC Class B computing device in accordance with the specifications in Subpart J of Part 15 of FCC Rules, which are designed to provide reasonable protection against such interference in a residential installation. However, there is no guarantee that interference will not occur in a particular installation. If this equipment does cause interference to radio or television reception, which can be determined by turning the equipment off and on, the user is encouraged to try to correct the interference by one or more of the following measures:

- Reorient the receiving antenna.
- Relocate the irrigation controller with respect to the receiver.
- Move the irrigation controller away from the receiver.
- Plug the irrigation controller into a different outlet so that the irrigation controller and receiver are on different branch circuits.

If necessary, the user should consult the dealer or an experienced radio/television technician for additional suggestions. The user may find the following booklet prepared by the Federal Communications Commission helpful:

"How to Identify and Resolve Radio-TV Interference Problems". This booklet is available from the U.S. Government Printing Office, Washington, DC 20402. Stock No. 004-000-00345-4.

International: This is a CISPR 22 Class B product.



The Toro Company
Irrigation Division
An ISO 9001 Certified Facility
P.O. Box 489
Riverside, California 92502

1-800 664-4740 (in USA) • 1-909-688-9221 (outside USA)